

SAURER.

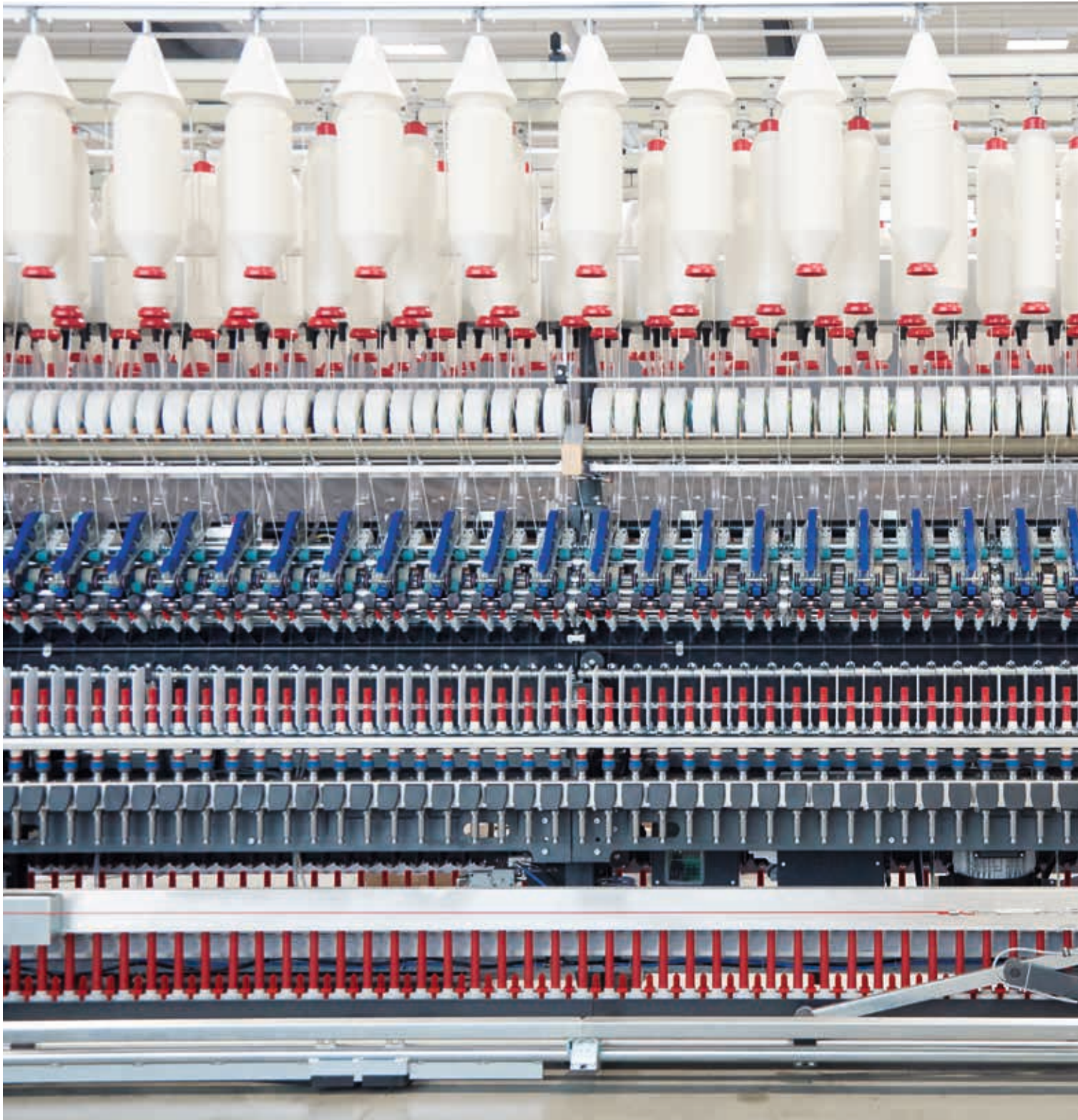

Versatility.

Drafting systems





Texparts offers high quality components for the textile industry. Being a specialist in engineering spinning components, Texparts is a world-class partner for its customers. The product portfolio comprises drafting systems for processing a wide variety of fibres as well as spindles, rings, travellers, bearings and other accessories for spinning.

Drafting systems play an important role in ensuring the quality of yarn in the spinning process. Today, increasing demand is being placed on modern ring-spinning machines with regards to yarn quality and process reliability. With millions of weighting arms installed, Saurer is the leading supplier of drafting systems for all kinds of fibres.

Contents

4
Drafting systems
for roving frames

10
Drafting systems for
short staple ring frames

18
Texparts components
for drafting systems

26
Complete drafting systems
overview

Drafting systems for roving frames

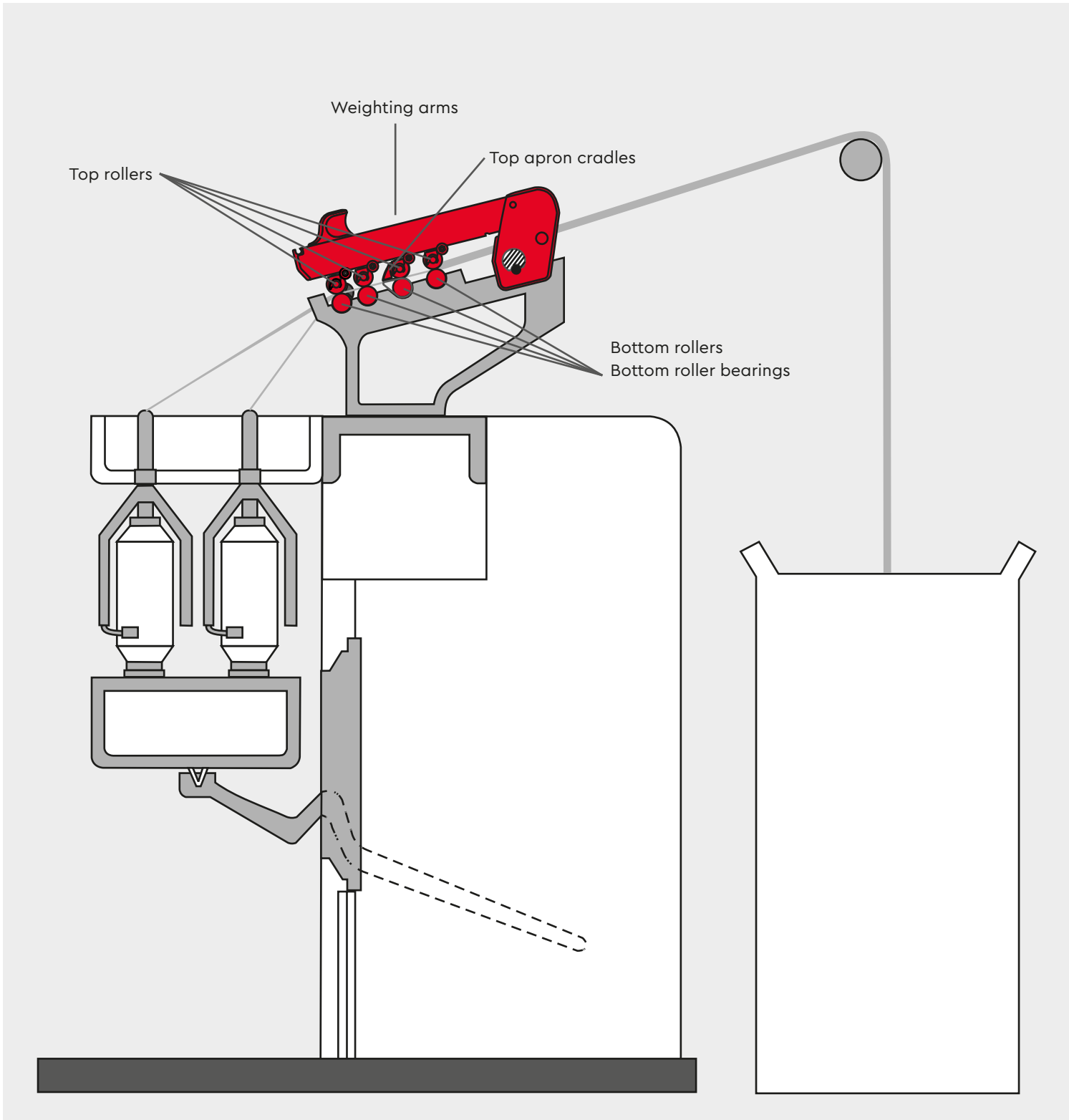

- **Flexibility for all fibres**
- **Highest process reliability**
- **Rovings of optimum quality**
- **Versatile portfolio**
 - **Pneumatic and mechanical weighting arms**
 - **3- and 4-roller versions**



PK 1550 mechanical weighting arms

Increased efficiency for the production of high quality rovings

The spring loaded weighting arms PK 1550 offer more flexibility for the spinning process and an improved process reliability, thus resulting in rovings of optimum quality. The PK 1550 weighting arms are intended for 3-roller and 4-roller drafting systems. They are suitable for spinning cotton, man-made fibres or blends thereof of up to approx. 60 mm length.

PK 1550 features:

- Optimised surface protection for long life
- Smaller load tolerances
- Visible load indicators
- Ergonomic handle
- Top apron cradle concept with individual tensioning system
- Easy disassembly of top rollers



Types

	Drafting system	Top roller diameter D
	3-roller version	28 mm
PK 1550	3-roller version	35 mm
	4-roller version	28 mm

Texparts components for PK 1550

Top apron cradle

OH 5022	For cotton and synthetic fibres up to approx. 45 mm fibre length
OH 5042	For long cotton fibres and synthetics up to 54 mm fibre length
OH 5245	For synthetics up to approx. 60 mm fibre length

Top rollers

LP 1015



PK 5000 pneumatic weighting arms

The PK 5000 series weighting arms are an innovative and future-oriented drafting system for short staple roving frames. It can be used for spinning of cotton, man-made fibres and combinations of these up to a fibre length of approx. 60 mm. The load on the top rollers is adjusted infinitely and centrally using a compressed air supply system. This ensures a constant load at all spinning positions of the roving frame. The PK 5000 weighting arm offers an extremely practical method of centralised partial load, which is easy to set and persuasively simple to operate.

PK 5000 features:

- Simple and easy to operate
- Rapid erection and setting
- Simple height adjustment
- Centralised and infinite load setting
- Practical and safe partial load
- Reduction in the operating forces



Types

Mainly used for the spinning of short fibres

	Drafting system	Top roller diameter D
PK 5025	3-roller version	28 mm
	4-roller version	28 mm

Mainly used for the spinning of longer fibres

	Drafting system	Top roller diameter D
PK 5035	3-roller version	35 mm
	4-roller version	35 mm

Texparts components for PK 5000

Top apron cradle

OH 5022	For cotton and synthetic fibres up to approx. 45 mm fibre length
OH 5042	For long cotton fibres and synthetics up to 54 mm fibre length
OH 5245	For synthetics up to approx. 60 mm fibre length Only for the 3-roller-version

Top rollers

LP 1015

Drafting systems for short staple ring frame

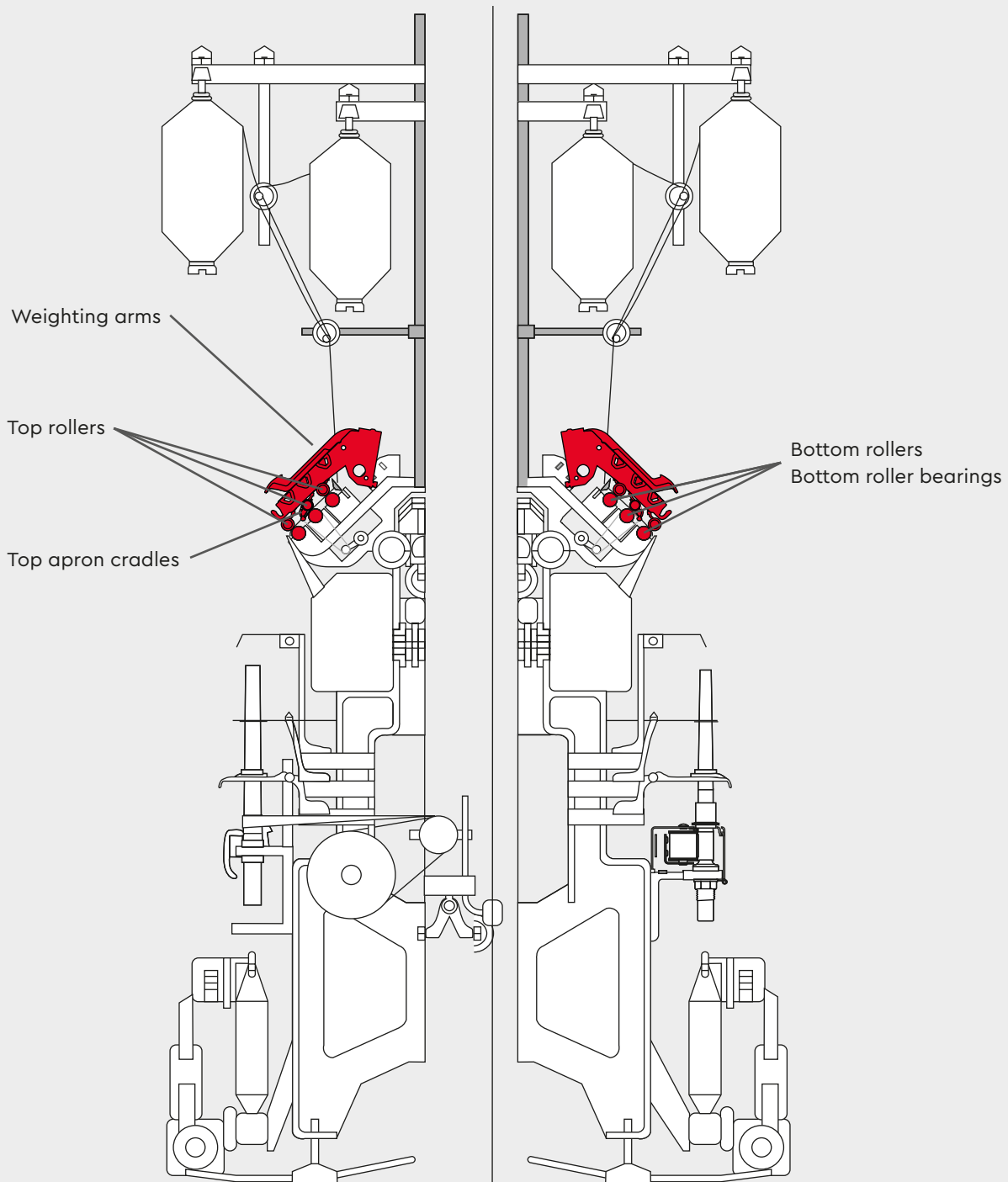

es

- **Versatile portfolio**
 - **Weighting arms for all machine types**
 - **For compact and conventional spinning**

- **Patented features:**
 - **EasyFit**
 - **EasySet**
 - **EasyHandle**
 - **EasyDraft**
 - **EasyIndicate**
 - **EasyAdapt**



PK 2630 SE series weighting arms

Patented features for increased customer benefits and higher flexibility in application

In today's market spinning mills have to be very flexible in order to meet the rapidly changing fashion and growing quality requirements:

- unsurpassed yarn quality
- suited for all fibres and yarn counts
- minimal variation of yarn quality between spinning positions
- reliable spinning processes and excellent quality
- high flexibility in weighting arm settings

With PK 2630 SE Texparts has developed a weighting arm to meet the requirements of the modern spinning mill.

Types

Mainly used for the spinning of short fibres

	Drafting system	Top roller diameter D
PK 2630 SE	3-roller version	30 mm
PK 2655 SE	3-roller V-draft	35 mm

Mainly used for the spinning of longer staple fibres

	Drafting system	Top roller diameter D
PK 2635 SE	3-roller version	35 mm
PK 2665 SE	3-roller V-draft	35 mm

Texparts components for PK 2630 SE

Top apron cradle	
OH 2122	For cotton fibres, synthetics and corresponding blends up to 45 mm fibre length
OH 2132	For long cotton fibres and synthetics up to 54 mm fibre length
OH 122	For synthetics up to approx. 60 mm fibre length
Top rollers	
LP 1002	
LP 1003	



EasyFit

Faster and easier fixing of the weighting arm on the support rod without damages. Fitting and adjustment by only one person. As less time is needed, the machine downtime is reduced.

EasySet

Quick and very accurate height setting. EasySet also ensures less variation of yarn quality from spinning position to spinning position.

EasyHandle

Ergonomic handle, optimized for easy handling based on a new lever construction. EasyHandle ensures opening and closing the weighting arm with the use of very little force.

EasyDraft

Independently working single elements with no load variation. Flexible settings of the draft field distances. The drafting system can be adapted easily to fibre properties and ever changing spinning requirements.

EasyIndicate

Enhanced load indication. Due to 5 possible load steps with a maximum load of 200N per element the fibre clamping and guidance is ensured in an optimal way. Variable load adaptation allows high technological flexibility, gentle treatment and reduced wear of related components. EasyIndicate enables an easy reading of the load and prevents false settings. Load settings can be checked even when the weighting arm is closed and is in its working position.



PK 2630 SEH series weighting arms

For ring-frames with hexagonal support rods

Minimal Maintenance

The PK 2630 SEH is a pure mechanical weighting arm, which hardly requires any maintenance at all. The loads are constant throughout the lifetime and do not need re-adjusting. This leads to a constant and uniform load and consequently high consistency in yarn quality.

The weighting arm can be adapted on the existing hexagonal support rod. In case of conversions, existing good quality top rollers can be used.

Texparts components for PK 2630 SEH

Top apron cradle

OH 2122	For cotton fibres, synthetics and corresponding blends up to 45 mm fibre length
OH 2132	For long cotton fibres and synthetics up to 54 mm fibre length

Top rollers

LP 1002
LP 1003



Compact adaptations

Compact systems in the market can be retrofitted to the well established weighting arms PK 2630 SE and PK 2630 SEH.

Advanced versatility

One advantage is that the front roller load can be set fully independently from the nip roller load. Consequently there is no interference between nip and front top roller. The front roller is fully seated in the guide arm and ensures best alignment to the specific requirement of the processed material.

Advantages of easy adaption

To adapt the compact systems to the weighting arms only the upper shell of the compact system has to be exchanged with our redesigned shell. The retrofitting is working for 4 cylinder compact systems with positive driven bottom rollers as well as for compact systems for weighting arms with hexagonal support rod.



PK 2000 Plus series weighting arms

The standard drafting system with a PLUS

The PK 2000 Plus can be applied on three-roller double-apron drafting systems on short staple ring spinning machines suitable for spinning pure cotton, man-made fibres or blends of both types up to 60 mm fibre length.

PK 2000 Plus features:

- Resistant surface due to special powder coating
- Top apron cradle concept with individual tensioning system
- Individual load adjustment



Types

Mainly used for the spinning of short fibres

	Drafting system	Top roller diameter D
PK 2025	3-roller standard	28 mm

Mainly used for the spinning of longer fibres

	Drafting system	Top roller diameter D
PK 2035	3-roller standard	35 mm

Texparts components for PK 2000 Plus

Top apron cradle

OH 2022	For cotton fibres, synthetics and corresponding blends
OH 62	up to 45 mm fibre length
OH 2042	For long cotton fibres and synthetics
OH 132	up to 54 mm fibre length
OH 122	For synthetics up to approx. 60 mm fibre length

Top rollers

LP 1002
LP 1003

Texparts components for drafting systems





- **All yarn quality determining components from one hand**
- **Covering the whole spinning process**
- **Market and innovation leadership in spinning components**
- **Components for all standard fibre lengths**





Top rollers

Top roller quality is of major importance for spinning quality yarn. The smooth running of the top roller in the direct contact with the roving influences the drafting result and herewith the quality.

Texparts top rollers are fitted with antifriction bearings. This brings advantage for all spinning processes (roving, ring spinning, compact spinning and worsted spinning). A wide range of top roller versions and gauges offers the ideal fit for every individual application. The top rollers are supplied without cot as a standard. All basic types can be delivered with ready ground cots according to customers specification for all types of rubber quality and dimensions.

Advantages

- Long service life at high load capacity due to optimized bearing seal
- Silent and smooth running performance
- Small roller diameters
- Minimized friction
- Long service intervals
- Simple maintenance



Top rollers for roving frames

Top roller LP 1015 is used for front and rear top roller. The spun material determines the used cots.

The following gauges are available:

Gauge in mm				
82.5	90.0	100.0	110.0	130.0

Top rollers for short staple ring frames

Based on the applied weighting arm, top rollers LP 1200 or LP 1000 are used as rear and front top rollers. The spun material determines the specification cots. LP 1203 and LP 1003 are developed for top apron rollers.

Depending on the application, LP 1200 or LP 1000 (with cots) are also suitable for top apron rollers. The following gauges are available:

Gauge in mm				
68.4	70.0	75.0	82.5	90.0

Advantages of the new LP 1200:

- Corrosion free saddle shaft
- Extreme high load capacity
- Absolute maintenance free



Top apron cradles

In terms of an optimized spinning process Texparts top apron cradles with individual apron tensioning concept offer decisive advantages. They are available for a wide range of fibre types and lengths as well as for every application in short and long staple spinning.

Features and Benefits

- Low friction and gentle apron running as a result of the special surface structure and an ideal combination of materials
- Ideal parallel positioning of top apron cradle and top roller
- Individual tensioning of aprons per spinning point
- Savings in time of up to 40% due to simple apron exchange without the need to remove the apron unit
- Lowest possible stress on fibres during drafting and gentle fibre guidance

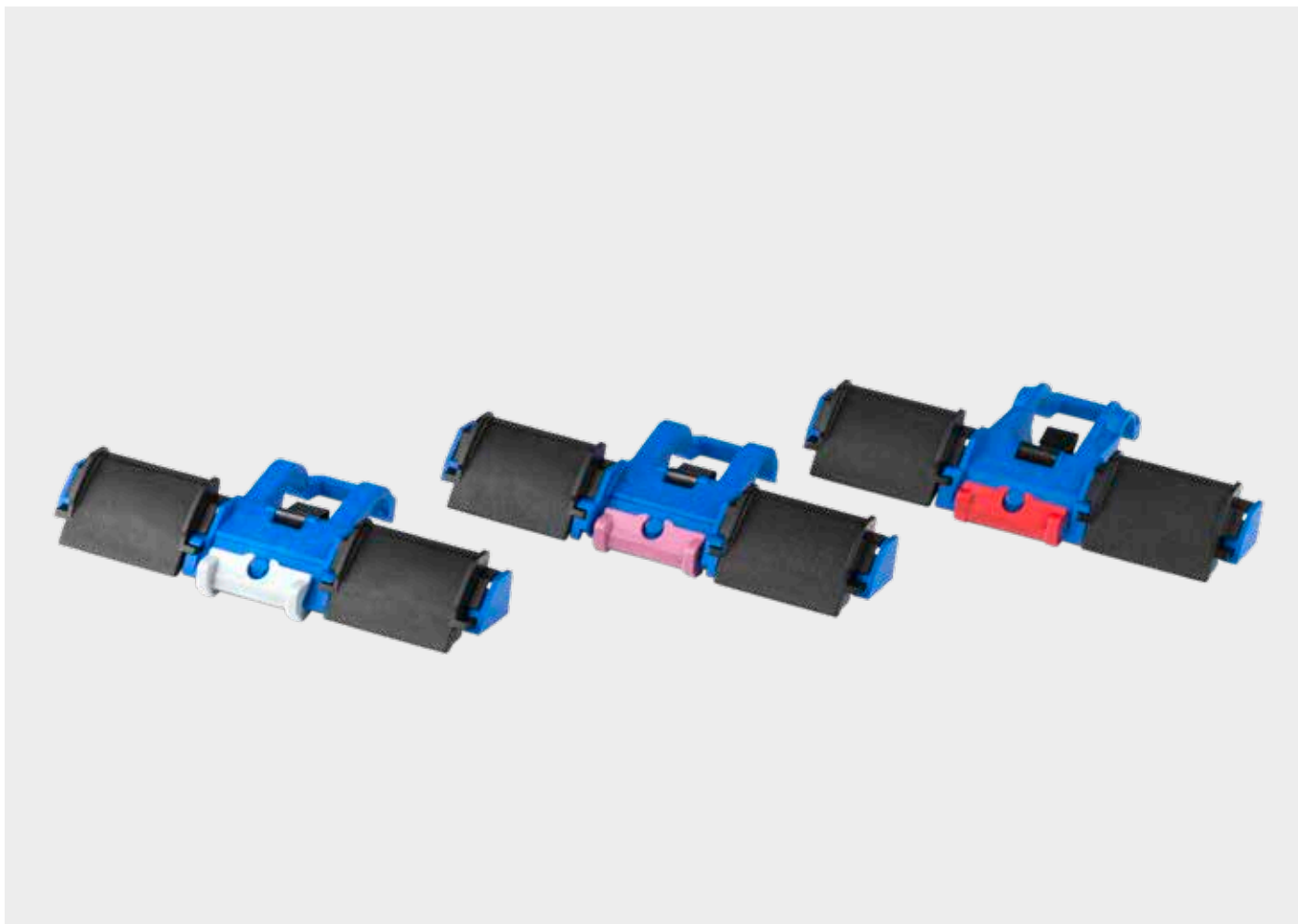

Top apron cradles for roving frames

Top apron cradle

OH 5022	For cotton and synthetic fibres up to approx. 45 mm fibre length
OH 5042	For long cotton fibres and synthetics up to 54 mm fibre length
OH 5245	For synthetics up to approx. 60 mm fibre length

Distance clips for top apron cradles for roving frames

Distance clip	Colour
OLC-0964 104	White
OLC-0964 106	Black
OLC-0964 108	Green

Top apron cradles for short staple ring frames

Top apron cradle

OH 2022	For cotton fibres, synthetics and corresponding blends up to 45 mm fibre length
OH 2122	
OH 2132	
OH 2142	For long cotton fibres and synthetics up to 54 mm fibre length

Distance clips for top apron cradles for short staple ring frames

	Distance clip	Colour
	OLC-0964 118	Yellow
OH 2022	OLC-0017 705	Lilac
	OLC-0964 119	White
	OLC-0017 627	Grey
OH 2122	OLC-0017 705	Lilac
	OLC-0964 119	White
	OLC-0017 705	Lilac
OH 2132	OLC-0964 119	White
	OLC-6006 661	Light Green
	OLC-0964 117	Red
OH 2142	OLC-0964 118	Yellow
	OLC-0964 119	White



Bottom rollers

The used raw material and the precision in manufacturing guarantee the bottom rollers quality. Texparts supplies hard-chrome plated bottom rollers for ring spinning machines and roving frames with extremely narrow tolerances.

Bottom rollers play a major role in ensuring yarn quality. Precise concentricity guarantees high yarn quality (evenness and strength). Equally influential to yarn breaks are the running conditions of the bottom rollers. Precise running bottom rollers allow to extend the spinning limits into finer yarn count ranges.



Bottom roller bearings

The precise needle bearings for ring spinning machines, roving frames, draw frames and air-jet spinning machines are renowned for their high load-bearing capacity.

Convincing advantages

- Absolutely quiet and precise running behaviour
- Optimum yarn evenness due to flawless flutes
- Extension of spinning limits into finer counts
- High load bearing capacity
- Smooth and jolt free start-up
- No yarn quality drop during start-up phase
- Dependable sealing of bearing against fibre fly and dirt
- Longer bearing life time

Complete drafting systems overview

Roving frame

Weighting arm

PK 5000

PK 1550



Top apron cradle

OH 5022
 OH 5042 (only in gg 110 mm)
 OH 5245 (only in gg 110 mm for the 3-roller-version)

OH 5022
 OH 5042 (only in gg 110 mm)
 OH 5245 (only in gg 110 mm)

Rear and front top roller

LP 1015

LP 1015

Top apron roller

LP 1015



LP 1015

Available gauge

90, 100, 110 mm

90, 100, 110 mm

Short staple ring frame

Weighting arm	PK 2630 SE Series	PK 2630 SEH	PK 2000 Plus
			
Top apron cradle	OH 2122 OH 2132 OH 2142 OH 122 (in gg 68.4, 75 and 82.5 mm)	OH 2122 OH 2132 OH 2142	OH 2022 (in gg 68.4, 75 and 82.5 mm) OH 62 (only in gg 90 mm) OH 2042 (in gg 68.4 and 75 mm) OH 132 (in gg 68.4, 75 and 82.5 mm) OH 122 (in gg 68.4, 75.0 and 82.5 mm)
Rear and front top roller	LP 1002	LP 1002	LP 1002
Top apron roller	LP 1003	LP 1003	LP 1003
Available gauges	70, 75 mm	70, 75 mm	68.4, 75, 82.5, 90 mm

Saurer Spinning Solutions GmbH & Co. KG
Location Fellbach
Maria-Merian-Str. 8
70736 Fellbach
Germany
T +49 711 58521 0
F +49 711 58521 59
info.texparts@saurer.com

Saurer Textile Solutions Pvt Ltd
105 Mettupalayam Road
Thudiyallur
Coimbatore 641 034
India
T +91 422 3074000
F +91 422 2644578
M +91 93441 93444
texpartsindia@vsnl.net

Saurer (Jiangsu) Textile Machinery Co. Ltd.
No. 9 Chang Yang Street
Suzhou Industrial Park
215024 Suzhou
Jiangsu Province
P. R. China
T +86 512 8188 5688
F +86 512 8188 5698
saurer.com